

Features and Benefits

- **Small Size and Lightweight**
- **Near Ideal Performance**
-Low insertion loss and good rejection
- **Precision**
-Low part-to-part variation
- **Ease of Assembly**
-Standard SMT Processes
- **Self-shielded**

Applications

- EW
- Radar
- SIGINT

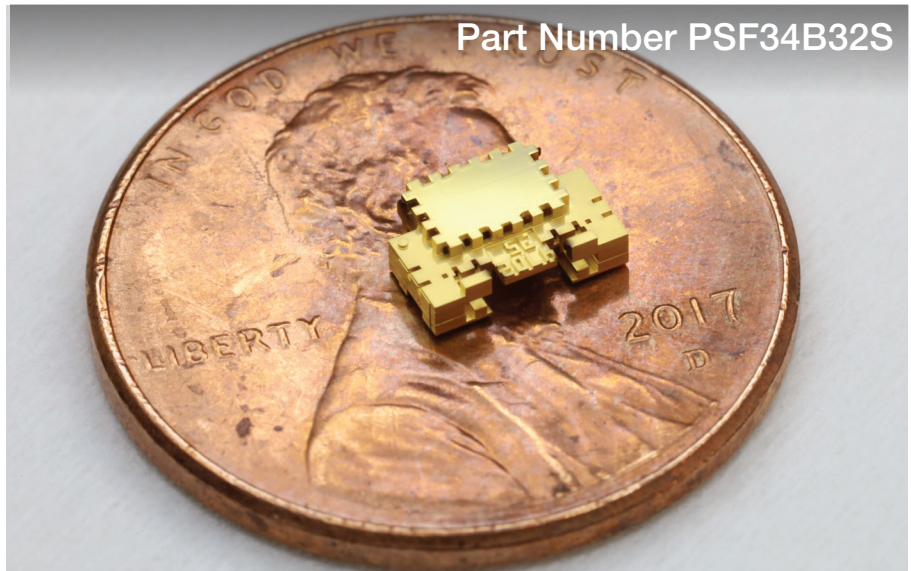

Part Number PSF34B32S

18-50 GHz Bandpass Filter

Surface mount wideband filter in a miniature form factor.

Description

Nuvotronics PolyStrata® Technology provides high performance filtering in a small form factor (5.8mm x 4.1mm x 1.60mm). The PSF34B32S surface-mount interdigital filter provides low insertion loss and high rejection. Typical insertion loss performance is < 0.4 dB across the 18 - 50 GHz band. This part is ideal for space or ground applications. This wideband filter is compliant with standard SMT assembly processes. Tape and reel packaging is available for bulk orders.

Typical Electrical Performance

Parameter	Frequency Range (GHz)	Min	Typ	Max
Insertion Loss (dB)	18 - 50	-	0.3	1.2
Return Loss (dB)		13	20	-
Rejection (dB)	DC - 15	40	45	-
	58 - 60	30	34	-

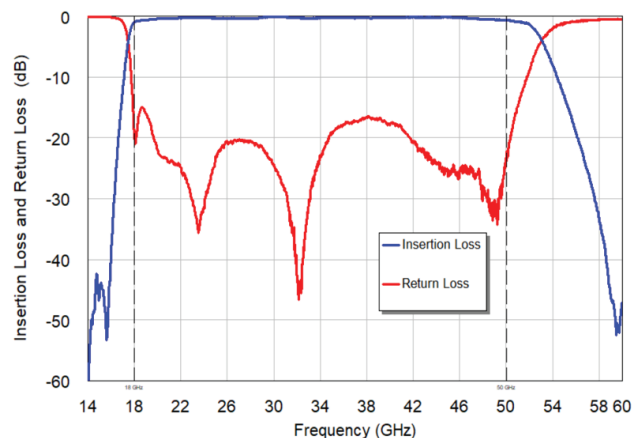

Additional Details

Special Handling / Storage Instructions	
Storage	IAW IPC-4553A
EDS Sensitivity	None
Ordering Information	PSF34B32S
Standard Packaging	Waffle Pack
Alternative Packaging Available	Tape and Reel
Component Termination Finish	Immersion Silver, Immersion Gold
Export Certifications	TBA

Absolute Maximum Ratings

Power	Minimum 2W CW
Operating Temp	-55°C to 125°C
Solder Reflow	260°C max. for 10 seconds, 3 cycles
Epoxy Attach	150°C max. for 90 minutes

Simplified Block Diagram

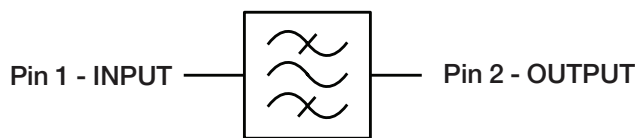

Component View

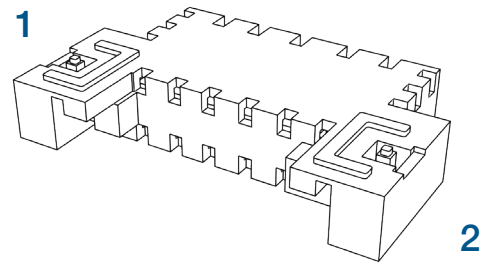

PCB Layout

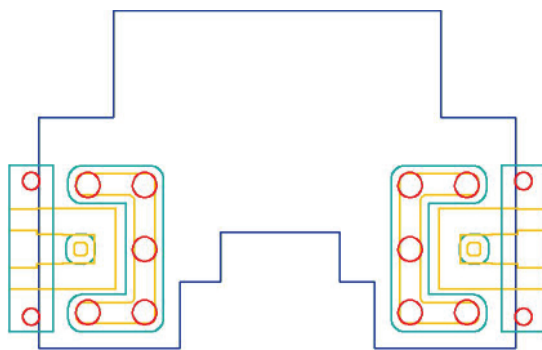

Legend: ■ PART OUTLINE ■ VIAS ■ SOLDER MASK

Drawings available upon request

Mechanical Drawing

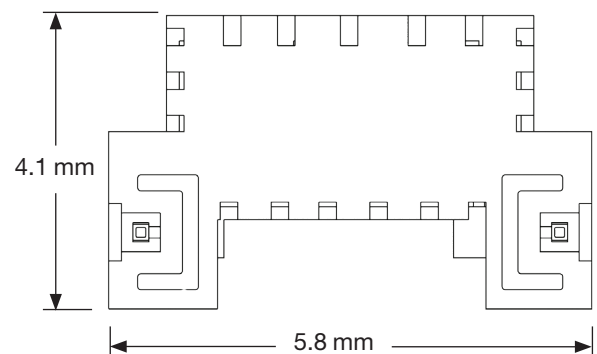

Top

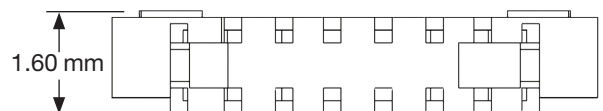

Front